

Date rev. Description

House	444,2720	Sheet	1
-------	----------	-------	---

Drawing	3D Plan	Scale	
---------	---------	-------	--

Material	4,4x135	Date	25.10.2021
----------	---------	------	------------

Drawer	RP	File	4442720 3D.dwg
--------	----	------	----------------

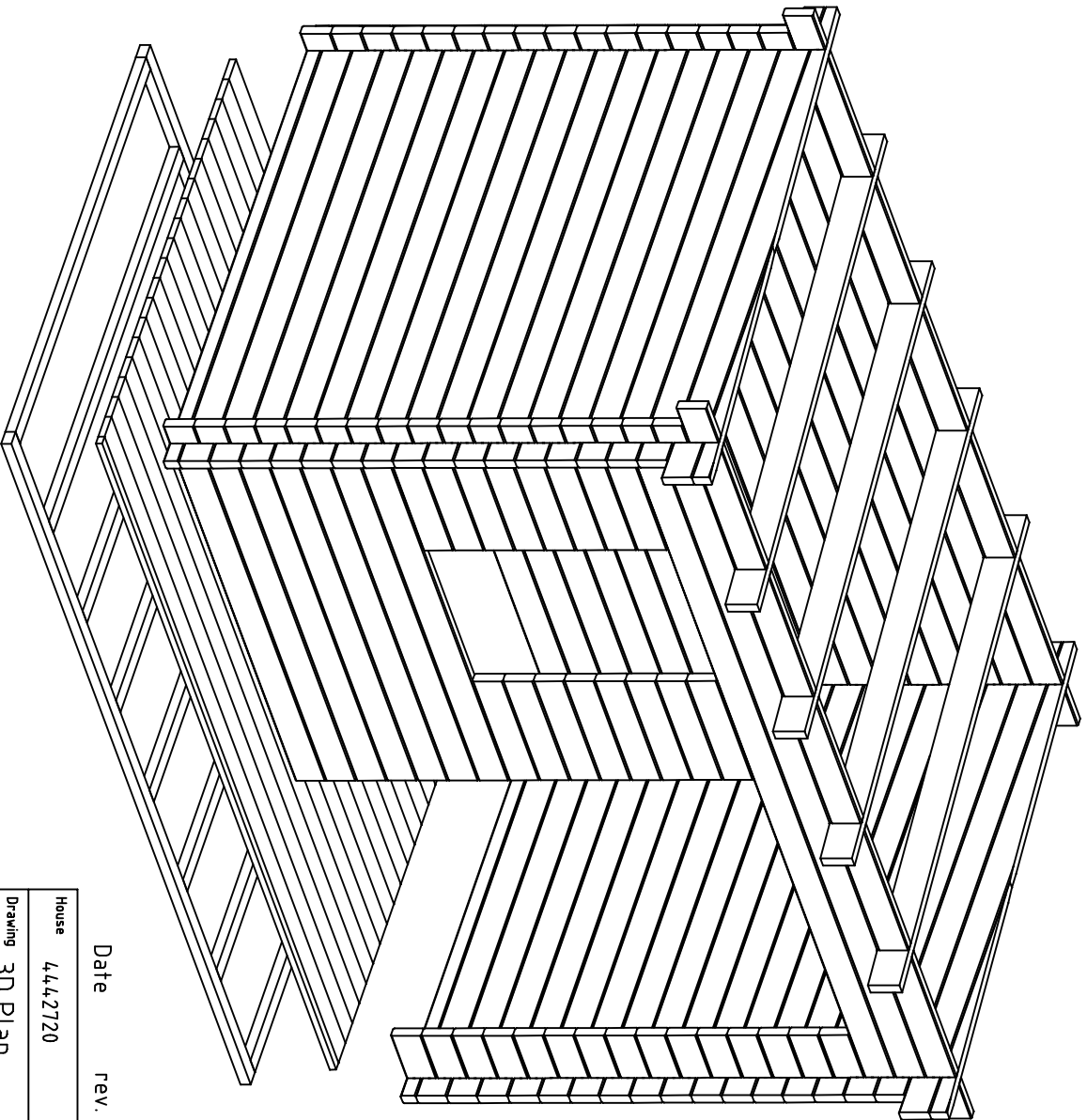

Date rev. Description

House	444,2720	Sheet	2
-------	----------	-------	---

Drawing	3D Plan	Scale	
---------	---------	-------	--

Material	4,4x135	Date	25.10.2021
----------	---------	------	------------

Drawer	RP	File	4442720_3D.dwg
--------	----	------	----------------

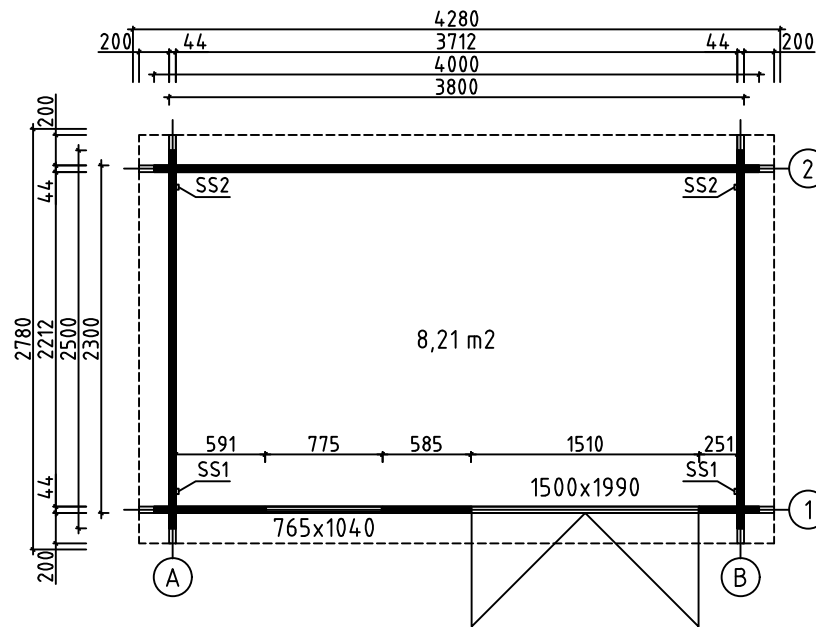

House	4442720	Sheet	3
Drawing	GROUNDPLAN	Scale	1:50
Material	44x135	Date	25.10.2021
Drawer	RP	File	4442720.dwg

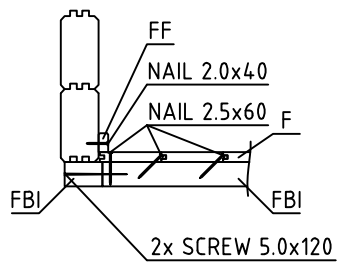
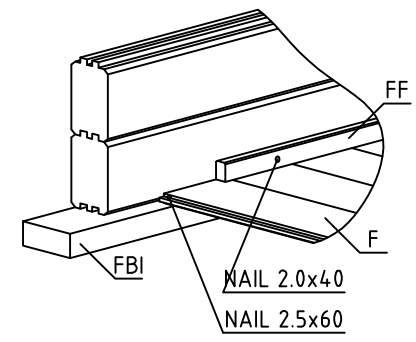
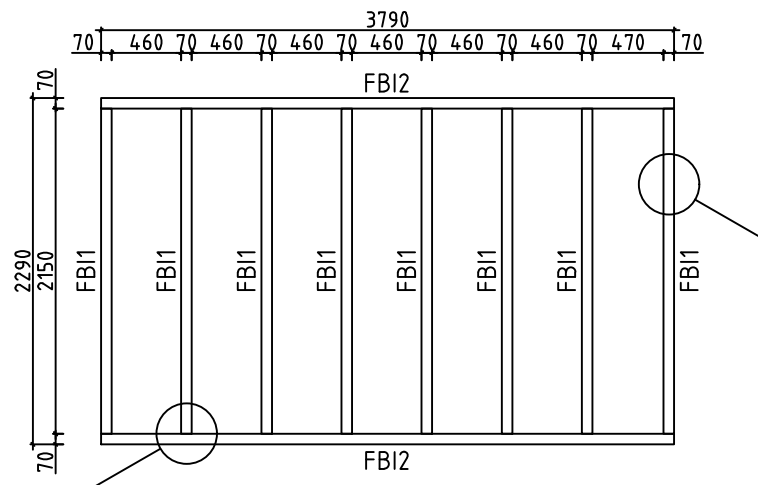

House	4442720	Sheet	4
Drawing	FLOORBEAMS	Scale	1:50
Material	70x45	Date	25.10.2021
Drawer	RP	File	4442720.dwg

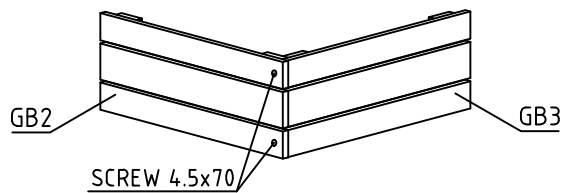
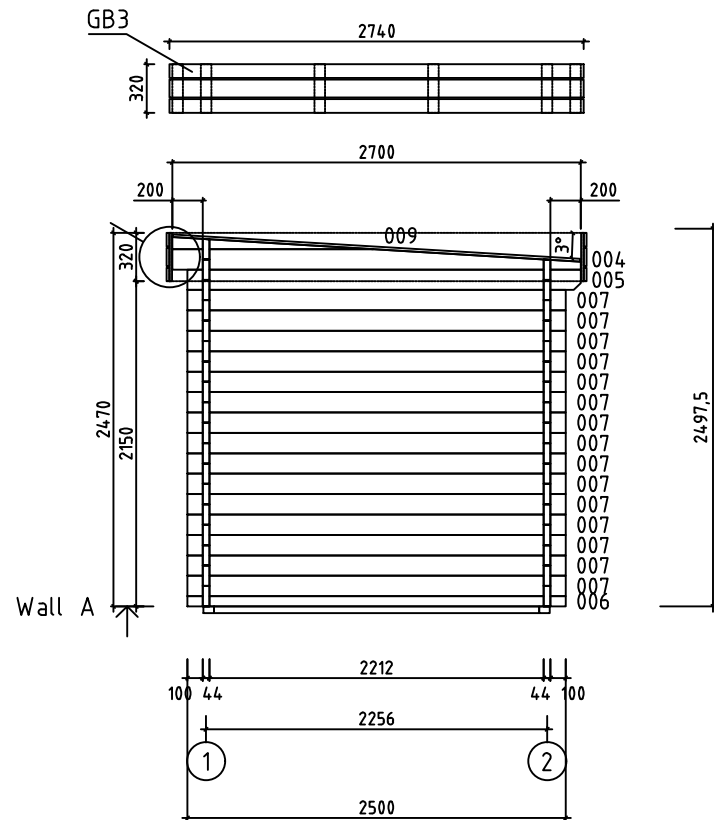
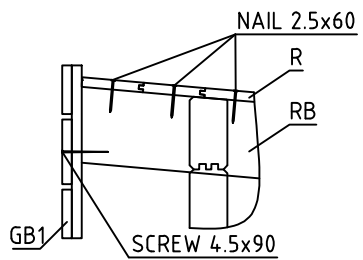
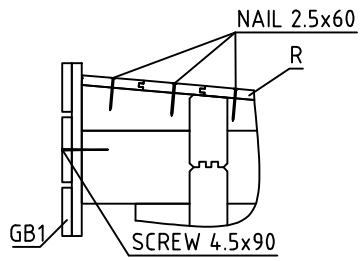

House	4442720	Sheet	5
Drawing	WALL A	Scale	1:50
Material	44x135	Date	25.10.2021
Drawer	RP	File	4442720.dwg

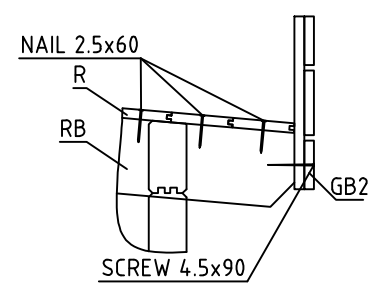
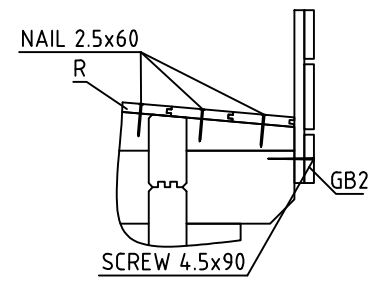
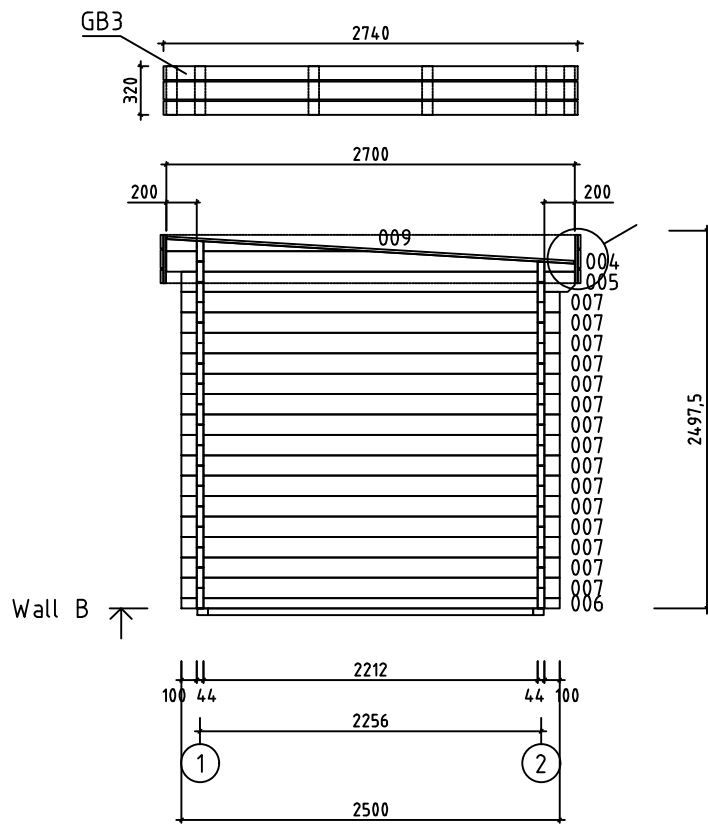



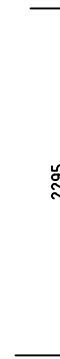
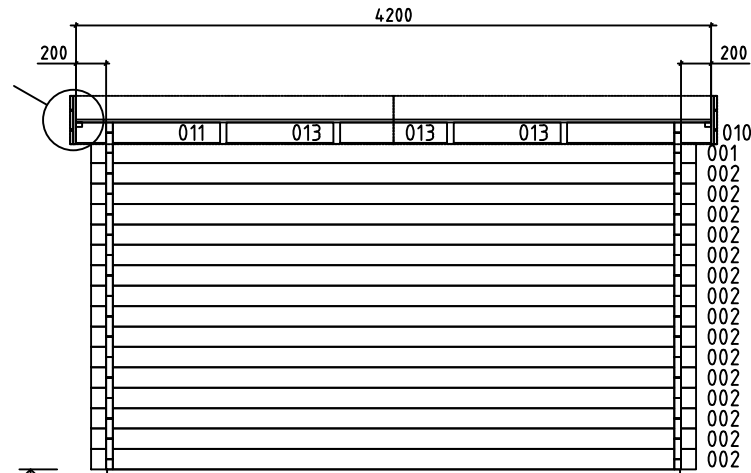
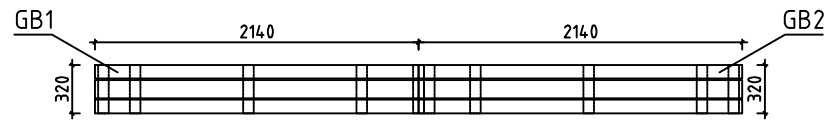
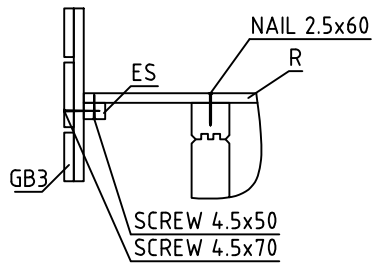
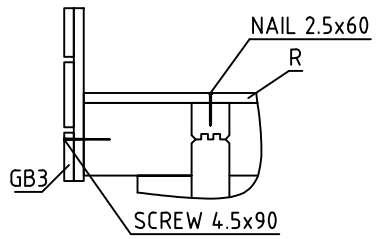



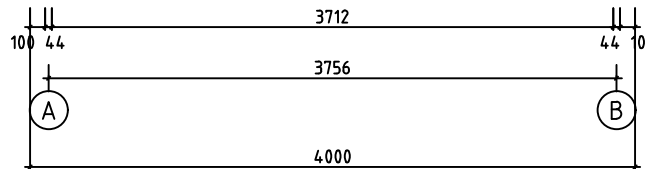

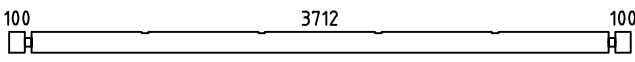
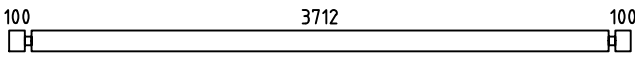
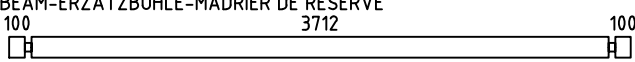
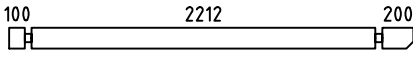
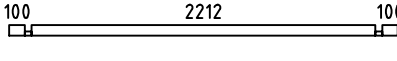
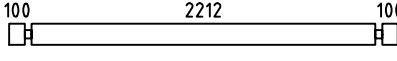
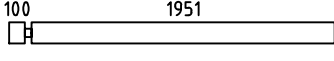
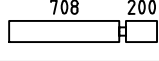
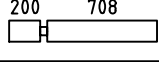
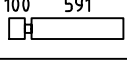
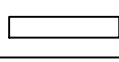
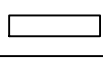

House	4442720	Sheet	6
Drawing	WALL B	Scale	1:50
Material	44x135	Date	25.10.2021
Drawer	RP	File	4442720.dwg

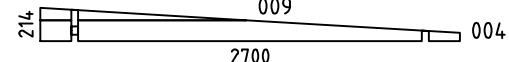

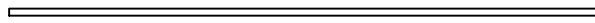





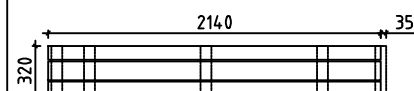
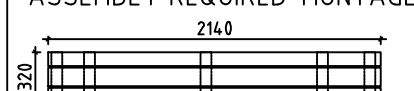

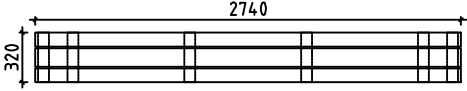







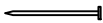



Wall 2 ↑

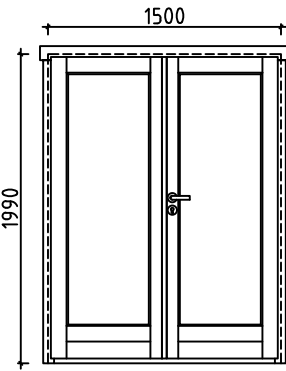





House	4442720	Sheet	8
Drawing	WALL 2	Scale	1:50
Material	44x135	Date	25.10.2021
Drawer	RP	File	4442720.dwg

Pos	Specification-Bestimmung-Spécification	PCS	Profile (mm)	L (mm)		
001		2	44x135	4000		
002		16	44x135	4000		
003	SPARE BEAM-ERZATZBOHLE-MADRIER DE RÉSERVE 	1	44x135	4000		
005		2	44x135	2600		
006		2	44x68	2500		
007		30	44x135	2500		
008		7	44x135	2095		
010		2	44x135	952		
011		2	44x135	952		
012		8	44x135	735		
013		6	44x135	708		
014		8	44x135	585		
015		15	44x135	395		
WA-1 WB-1		2	44x214	2700		
HB	HIT BLOCK-SCHLAGHÖLZER-MADRIERS D'ASSEMBLAGE 	2	44x135	300		
FBI2	FLOORBEAMS-FUSSBODENBALKEN-POUTRES DE FONDATION IMPRÉGNÉS 	IMM	2	70x45	3790	
FBI1	FLOORBEAMS-FUSSBODENBALKEN-POUTRES DE FONDATION IMPRÉGNÉS 	IMM	8	70x45	2150	
RB1	ROOFBEAMS-DACHBALKEN-SOLIVES DE PLAFOND 	4	43x140	2713		
F1	FLOORBOARD-FUSSBODENBRETT-PLANCHER  or-oder-ou	20+1 26+1	28x114 28x88	3705		
R1	ROOFBOARD-DACHBRETT-VOLIGES  or-oder-ou	24+1 31+1	18x114 18x88	4200		
FF1	FLOOR FILLET-FUSSBODENLEISTE-BAGUETTE DE FINITION DE PLANCHER 		18x35	12m		
GB1	ASSEMBLY REQUIRED-MONTAGE ERFORDERLICH-ASSEMBLAGE REQUIS 	2	36x320	2140 +35		
GB2	ASSEMBLY REQUIRED-MONTAGE ERFORDERLICH-ASSEMBLAGE REQUIS 	2	36x320	2140		
House	4442720	Material	File	4442720.dwg	Sheet	9

Pos	Specification-Bestimmung-Spécification	PCS	Profile (mm)	L (mm)		
GB3	ASSEMBLY REQUIRED-MONTAGE ERFORDERLICH-ASSEMBLAGE REQUIS 	2	36x320	2740		
ES1	EAVE SLAT-TRAUFENLEISTE-BAGUETTES POUR FIXER LES LATTES SOUS VOLIGES 	2	30x40	2210		
ES2	EAVE SLAT-TRAUFENLEISTE-BAGUETTES POUR FIXER LES LATTES SOUS VOLIGES 	4	30x40	200		
SS1	STORM SLAT-STURMLEISTE -BAGUETTE DE TEMPETE 	2	18x35	2290		
SS2	STORM SLAT-STURMLEISTE -BAGUETTE DE TEMPETE 	2	18x35	2160		
	SCREWS-SCHRAUBEN-VISSE FOR-FÜR-POUR SS1, SS2 	12	Ø6.0	50		
	WASHER-SCHEIBE-RONDELLE FOR-FÜR-POUR SS1, SS2 	12	Ø6.0	18		
	NAIL-NAGEL-CLOUS FOR-FÜR-POUR FF1 	30	Ø2.0	40		
	NAIL-NAGEL-CLOUS FOR-FÜR-POUR F1, R1 	410	Ø2.5	60		
	SCREWS-SCHRAUBEN-VIS FOR-FÜR-POUR GB1, GB2, GB3 	198	Ø3.5	35		
	SCREWS-SCHRAUBEN-VIS FOR-FÜR-POUR ES1, ES2 	20	Ø4.5	50		
	SCREWS-SCHRAUBEN-VIS FOR-FÜR-POUR GB1, GB2, GB3 	20	Ø4.5	70		
	SCREWS-SCHRAUBEN-VIS FOR-FÜR-POUR 006 GB1, GB2, GB3 	30	Ø4.5	90		
	SCREWS-SCHRAUBEN-VIS FOR-FÜR-POUR FBI1, FBI2 	32	Ø5.0	120		
	SCREWS-SCHRAUBEN-VIS FOR-FÜR-POUR 010, 011, 013 WA-1, WB-1, RB1 	40	Ø6.0	160		
	DOUBLEDOR-DOPPELTÜR-DUBBELE DEUR (right-rechts-rechts) AST_PRE_KARP      	1	1500	1990		
House	4442720	Material	File	4442720.dwg	Sheet	10

Pos	Specification-Bestimmung-Spécification	PCS	Profile (mm)	L (mm)
	<p data-bbox="264 136 1046 174">WINDOW-FENSTER-FENÊTRE (right-rechts-droit) AST_1H_KAR</p> 	<p data-bbox="1238 147 1254 174">P</p> <p data-bbox="1297 147 1313 174">1</p> <p data-bbox="1297 230 1313 257">1</p> <p data-bbox="1297 313 1313 340">1</p>	<p data-bbox="1377 147 1425 174">765</p>	<p data-bbox="1485 147 1533 174">1040</p>
House 4442720	Material	File 4442720.dwg	Sheet 11	

Pos	Assembly Instructions-Montageanleitungen-Instructions de Montage	PCS	Profile (mm)	L (mm)
L1	BOARD-BRETT-PLANCHE 	4	18x120	2140
L2	BOARD-BRETT-PLANCHE 	8	18x90	2140
L3	BOARD-BRETT-PLANCHE 	2	18x120	2740
L4	BOARD-BRETT-PLANCHE 	4	18x90	2740
L5	BOARD-BRETT-PLANCHE 	32	18x70	320

GB1

2 36x320

2140
+35

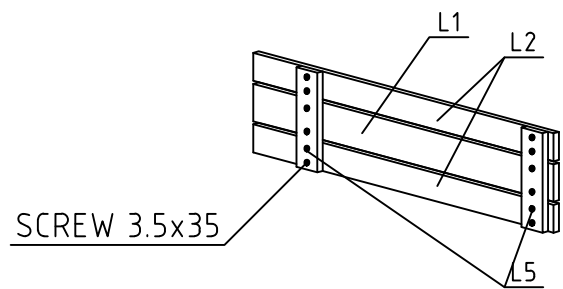
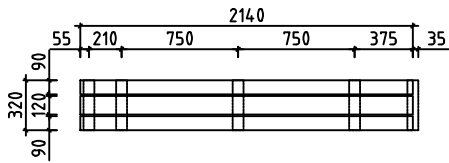

GB2

2 36x320

2140

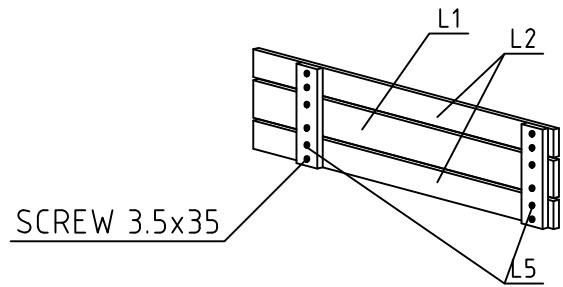
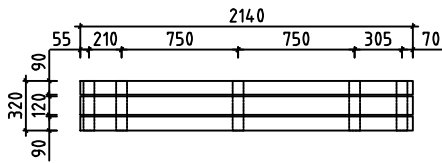

GB3

2 36x320

2740

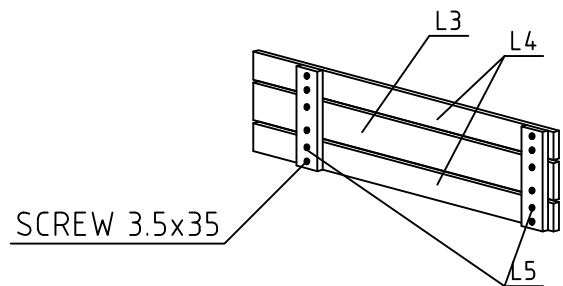
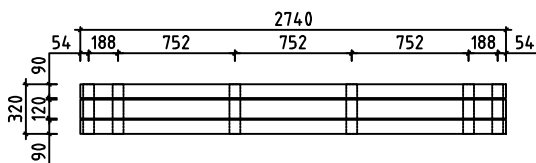

#001	1,2	4000	2
#002	1,2	4000	16
#003		4000	1
#004	A,B	2700	2
#005	A,B	2600	2
#006	A,B	2500	2
#007	A,B	2500	30
#008	1	2095	7
#009	A,B	1328	2
#010	1,2	952	2
#011	1,2	952	2
#012	1	735	8
#013	1,2	708	6
#014	1	585	8
#015	1	395	15